

MAIR100 series

AIR UNIT (PRECISION REGULATOR)



mindman



Symbol

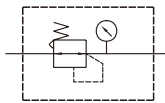

Caution

- Supply air must be dry and dust free. Mist separator must be used to guarantee correct operation of unit.
- Air is normally being discharged to the atmosphere from a bleed hole or an exhaust port.

Order example

MAIR100 – 6A – 2K – C – □

MODEL

PORT SIZE
6A: 1/8

ADJUSTABLE PRESS. RANGE
2K: 0.005~0.2 MPa
4K: 0.01~0.4 MPa
8K: 0.01~0.8 MPa

Blank: Without pressure gauge
C: Pressure gauge (PG-33S)

PORT THREAD
Blank: Rc thread
G: G thread
NPT: NPT thread

Specification

Model	MAIR100
Bore No.	6A
Port size	1/8
Medium	Air
Max. operating pressure	1 MPa
Min. operating pressure	Setting pressure+0.05 MPa
Proof pressure	1.5 MPa
Regulated pressure range	2K: 0.005~0.2 MPa
	4K: 0.01~0.4 MPa
	8K: 0.01~0.8 MPa
Sensitivity	0.2% F.S.
Repeatability	±0.5% F.S.
Air consumption (*)	4.4 ℓ/min(ANR) F.S.
Ambient temperature	-5~+60°C (No freezing)
Attachment	Bracket
Option	Pressure gauge (PG-33S)
Weight	150 g

* For supply pressure 1 MPa.

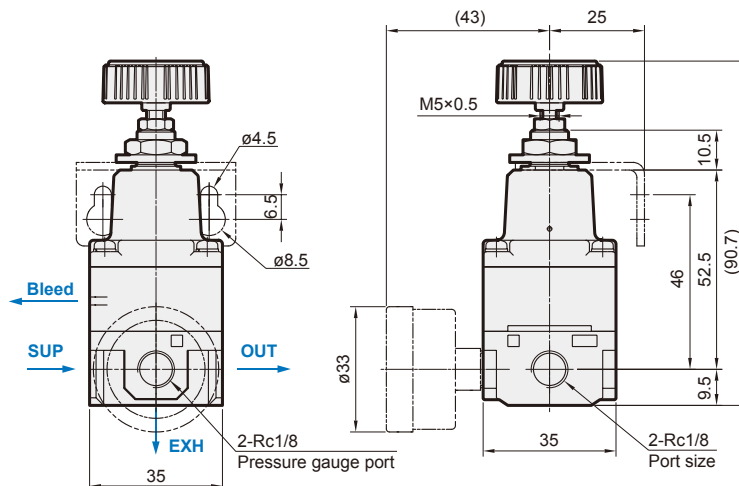
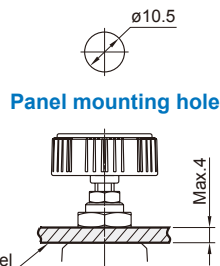
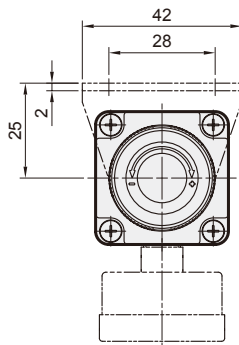

Flow feature

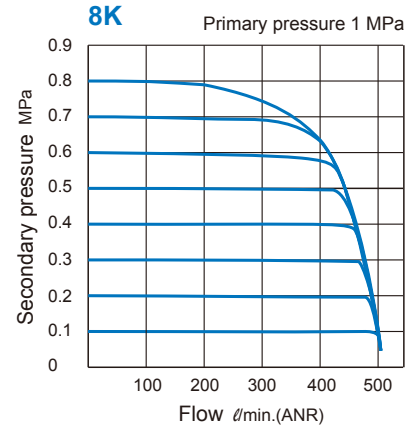
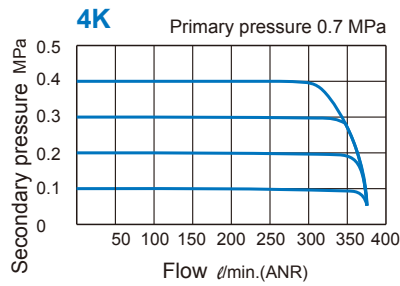
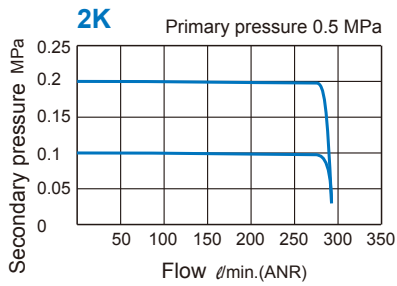

Relief characteristics

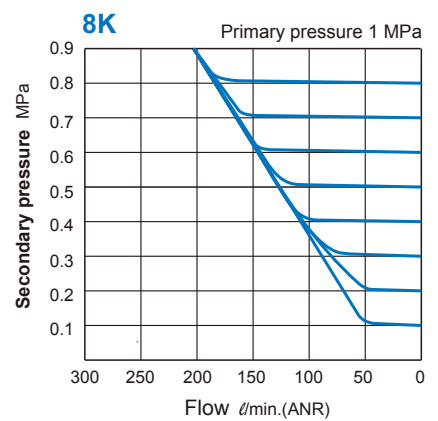
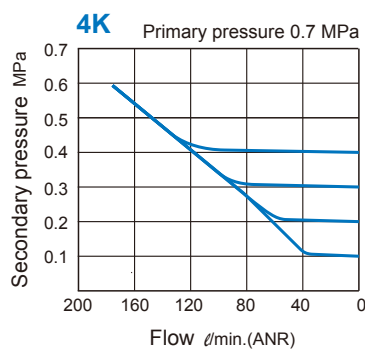
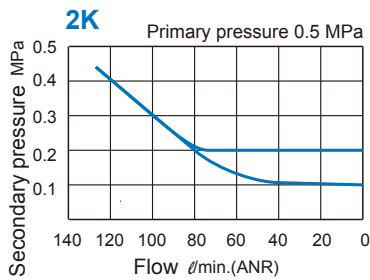

Pressure characteristics

