

MAF403 series

AIR UNIT (FILTER)

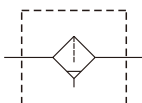

Symbol



Specification

Model	MAF403		
Bore No.	8A	10A	15A
Port size	1/4	3/8	1/2
Medium	Air		
Operating pressure range (※)	0.05~1 MPa		
Proof pressure	1.5 MPa		
Ambient temperature	-5~+60°C (No freezing)		
Filter element	Standard: 40 μm, Option: 5 μm		
Weight	345 g		

※1. Standard unit contains semi-auto-drain function when operating pressure below 0.05 MPa.

※2. Choose auto-drain FMRF300, the pressure range is 0.15 ~ 1 MPa.

Order example

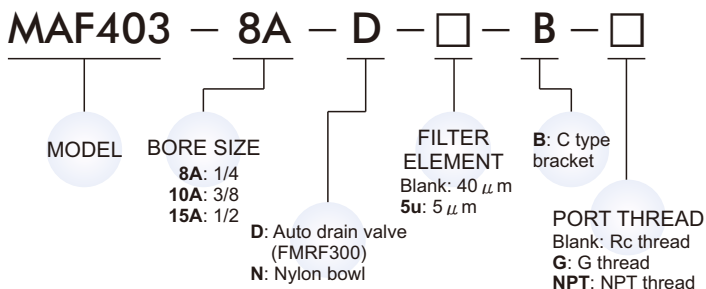

Option accessories

C type bracket

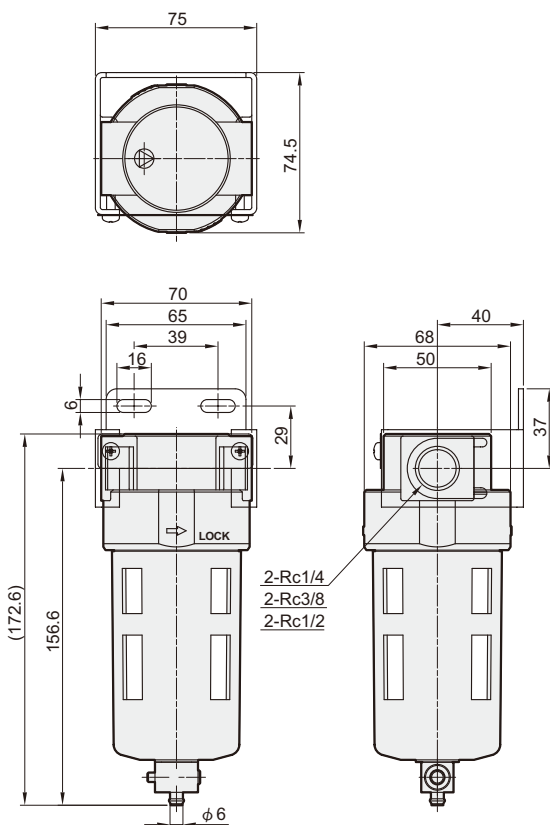
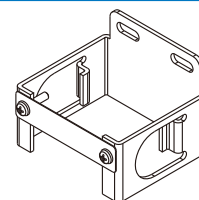

Flow feature

